

DATE:
January 26, 2018
CATALOG NO.
CDP0406R

OUTLINE DIMENSIONS
3-PHASE INDUCTION MOTOR

MOTOR TYPE:
AEHHGD
FRAME NO. 364T

Pole	HP	kW	Hz	VOLT	r/min
6	40	29.8	60	230/460	1200
Ins	Rating	Dimension in	Approx Weight	Bearings	
F	CONT.	inches	945 LBS.	DE: NU313	NDE: 6213

Totally Enclosed Fan-Cooled Type. Squirrel-Cage Rotor.

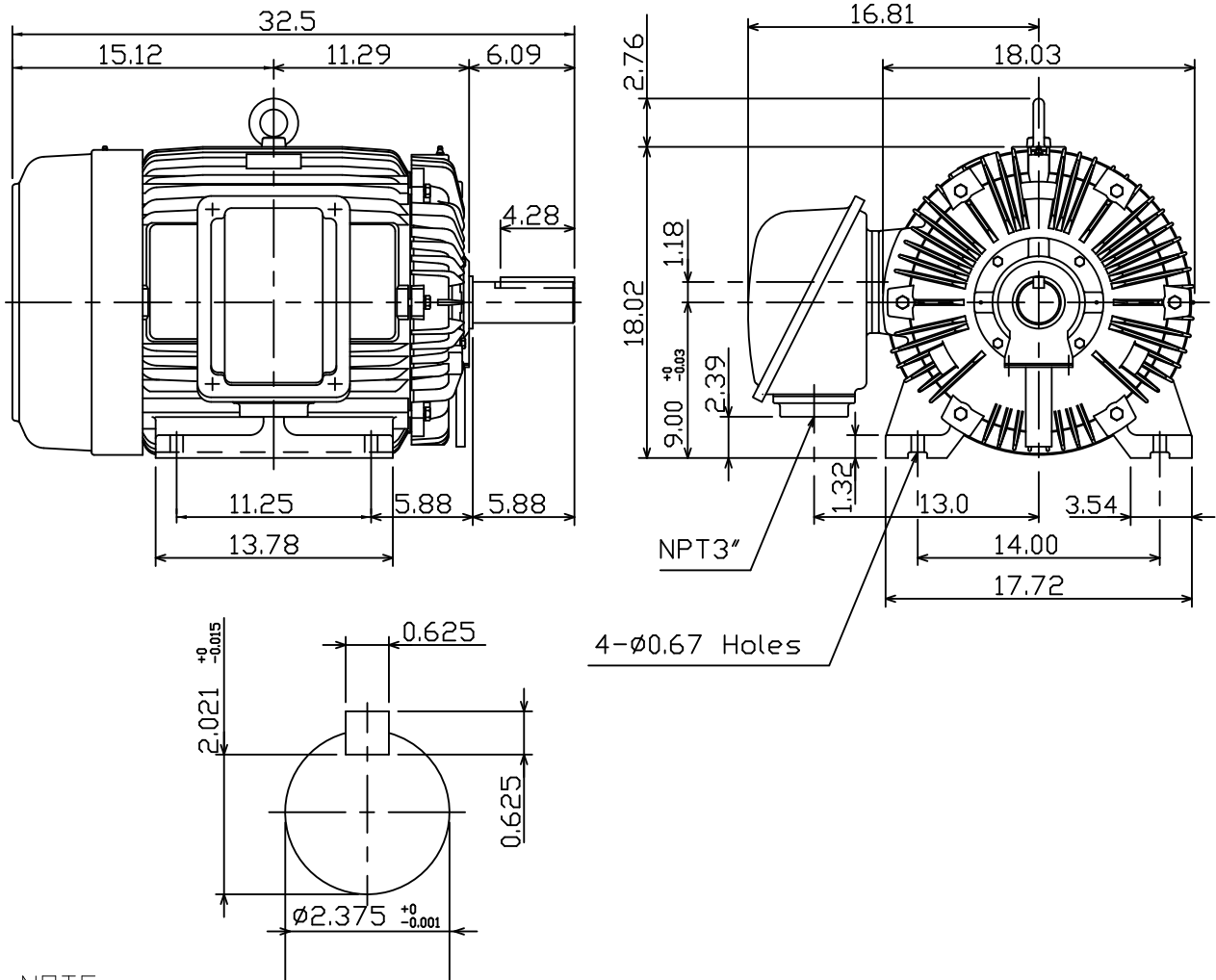

NOTE:

1. ENCLOSURE: IP55
2. SHAFT MATERIAL: SCM440 Q&T (AISI 4140 EQUIV)
3. WITH THERMISTOR: PTC 140°C x 3PCS
WIRED IN MAIN TERMINAL BOX



DWG.	C.COOK	02-01-18
------	--------	----------

TECO Westinghouse

DWG NO.
31057H913530